

# REDNET **AM2**

## User Guide

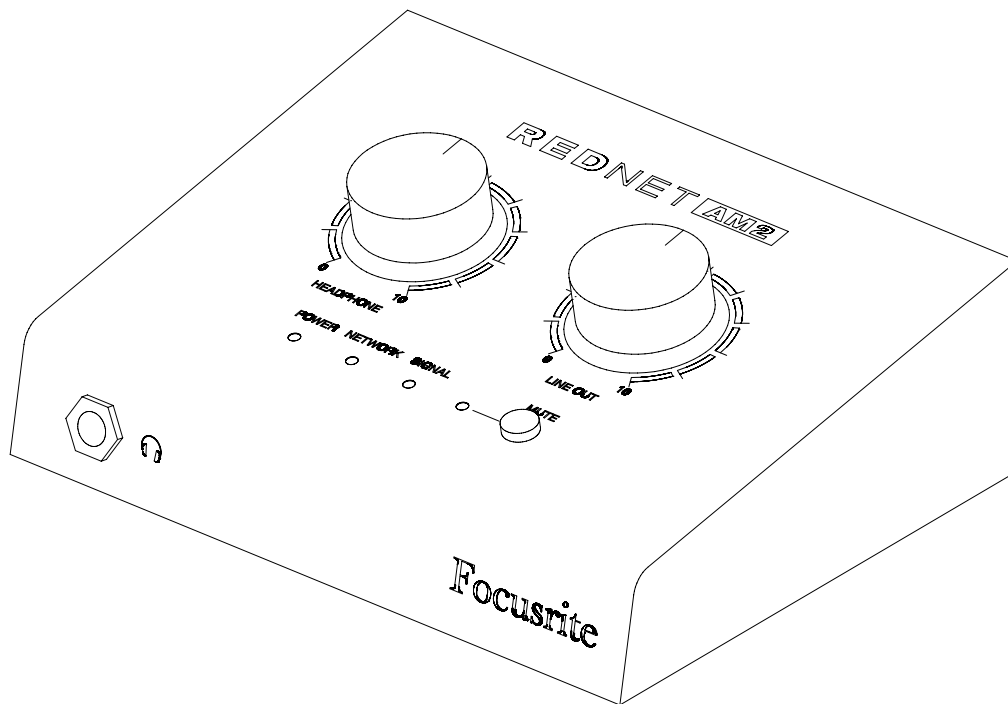

**Focusrite®**

[www.focusrite.com](http://www.focusrite.com)

# CONTENTS

About this User Guide .....	3
Box Contents .....	3
<b>INTRODUCTION .....</b>	<b>4</b>
<b>INSTALLATION GUIDE .....</b>	<b>5</b>
RedNet AM2 Connections and Features .....	5
Top Panel .....	5
Rear Panel .....	7
Physical Characteristics .....	8
Power Requirements .....	8
<b>REDNET AM2 OPERATION .....</b>	<b>9</b>
First Use and Firmware Updates .....	9
Digital Clocking .....	9
Pull Up and Pull Down Operation .....	9
<b>OTHER REDNET SYSTEM COMPONENTS .....</b>	<b>10</b>
<b>USING REDNET CONTROL .....</b>	<b>10</b>
Reverse ID .....	10
Signal Metering .....	10
ID (Identification) .....	11
Tools Menu .....	11
<b>APPENDIX .....</b>	<b>12</b>
Connector Pinouts .....	12
Ethernet Connectors (Dante) .....	12
XLR Connectors .....	12
1/4" Jack Connector .....	12
<b>PERFORMANCE AND SPECIFICATIONS .....</b>	<b>13</b>
Focusrite RedNet Warranty and Service .....	15
Registering Your Product .....	15
Customer Support and Unit Servicing .....	15
Troubleshooting .....	15

## About this User Guide

This user guide applies to the RedNet AM2 Dante headphone and line output interface. It provides information about installing and using the unit, and how it can be connected into your system.

A RedNet System User Guide is also available from the RedNet product pages of the Focusrite website. The guide provides a detailed explanation of the RedNet system concept, that will help you achieve a thorough understanding of its capabilities. We recommend that all users, including those already experienced in digital audio networking, take the time to read through the System User Guide so that they are fully aware of all the possibilities that RedNet and its software have to offer.

Should either user guide not provide the information you need, be sure to consult:

[www.focusrite.com/rednet](http://www.focusrite.com/rednet), which contains a comprehensive collection of common technical support queries.

## Box Contents

- RedNet AM2 unit
- DC power supply
- Safety information cut sheet
- RedNet Getting Started Guide
- Product Registration Card – please follow the instructions on the card as it provides links to:
  - RedNet Control
  - RedNet PCIe drivers (*included with RedNet Control download*)
  - Audinate Dante Controller (*installed with RedNet Control*)

*Dante™ and Audinate™ are registered trademarks of Audinate Pty Ltd.*

# INTRODUCTION

Thank you for purchasing the Focusrite RedNet AM2.



RedNet AM2 provides two channels of premium D-A conversion in the form of a stereo monitoring unit, combining headphone and line outputs for monitoring of signals from the Dante Audio-over-IP network.

RedNet AM2 includes two line-output XLRs plus a stereo TRS 1/4" jack socket. It provides high-quality digital to analogue conversion for accurate monitoring on loudspeakers or headphones and is designed to drive high or low impedance headphones at high levels with significant audio output power. Two large volume control knobs are provided for Headphone and Line output levels, the latter featuring a mute button with associated LED.

The compact unit, mounted in an enclosure based around a sturdy road-worthy aluminium extrusion, is fitted with non-slip feet and can either sit securely on a flat surface or be mounted on top of a mic stand using the 3/8" BSW threaded bush incorporated in the base.

Dual locking etherCON connectors are included on the rear-panel to connect to the network and to daisy-chain to additional network devices.

The unit is powered via Power over Ethernet (PoE) or via the rear-panel barrel connector and included DC power supply. Each PSU's status can be monitored remotely over the network and on the top panel.

Tailored for all environments, each unit features two network ports, PoE and DC power options, rugged construction with latching connectors and remote monitoring – RedNet AM2 is the perfect portable break-out solution for analogue monitoring from a Dante network.

# INSTALLATION GUIDE

## RedNet AM2 Connections and Features

### Top Panel

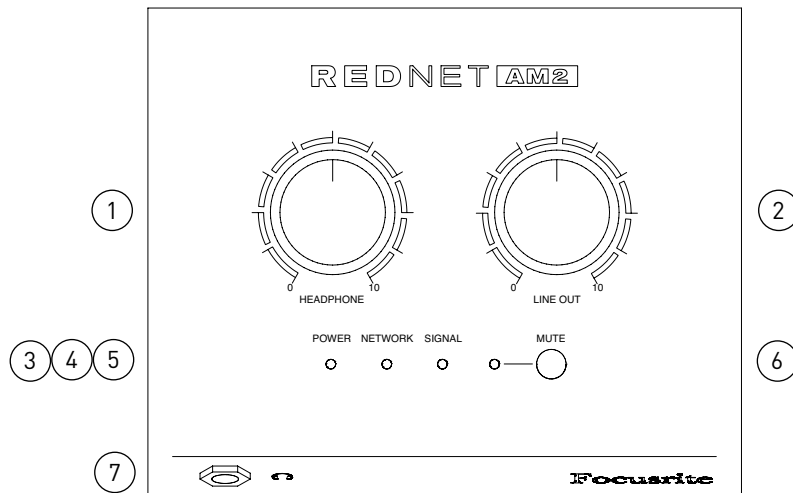

#### 1. Headphone Level Pot

Controls the volume level sent to the stereo headphone jack.

#### 2. Line Out Level Pot

Controls the volume level sent to the Line Output XLRs.

#### 3. Power Indicator

Bi-colour LED indicates the power source being used:

- Green: Power over Ethernet (PoE)
- Red: External DC supply

#### 4. RedNet Network Status Indicator

Tri-colour LED indicates the network status:

- Red (flashing) – Device is attempting to identify a network
- Red/Green (flashing) – Device is trying to lock to an identified network
- Green – Device is locked to the network and is capable of passing audio

## Top Panel ... Continued

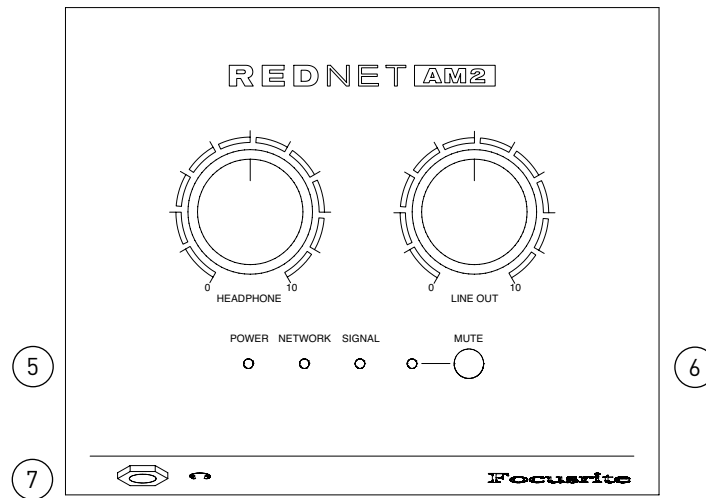

### 5. Signal Level Indicator

Tri-colour LED indicates the highest signal level of the network receivers:

- Green: Signal present (illuminates at -42 dBFS)
- Orange: -6 dBFS
- Red: 0 dBFS

*ID Indication – When the RedNet Control or Dante Controller applications send an ID command to the RedNet AM2 unit, the **Network** (4) and **Signal** (5) LEDs will cycle through green–orange–red states for 10 seconds.*

### 6. Line Out Mute / Reverse ID Switch

Press to mute the line output XLRs – the LED illuminates red when mute is active.

Press-and-hold the Mute button for 3 seconds to 'push' Reverse ID to the RedNet Control application.

### 7. Headphone Input

Standard 1/4" stereo Jack for headphones.

## Rear Panel

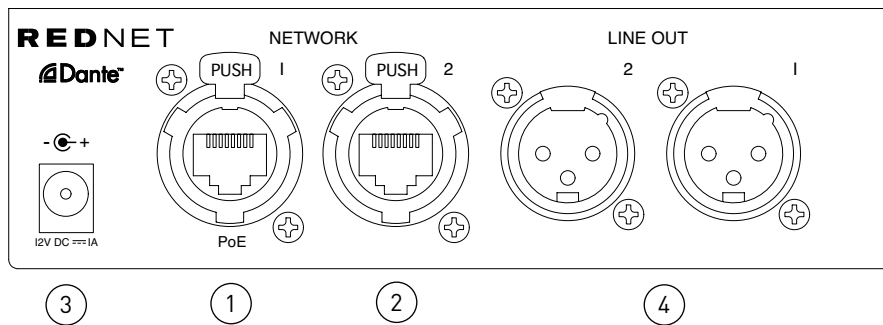

### 1. Network Port 1 / Primary Power Input\*

RJ45 [etherCON] connector for the Dante network. Use standard Cat 5e or Cat 6 network cables to connect RedNet AM2 to an Ethernet network switch.

Power over Ethernet (PoE) can be used to power the RedNet AM2. Connect an appropriately powered Ethernet cable to network port 1.

### 2. Network Port 2

Second RJ45 [etherCON] network port which can be used to daisy-chain additional devices.

*This port does not accept PoE input and does not pass power out.*

*This port cannot be used as the secondary connection on redundant networks – network ports 1 and 2 always function as a 2-port switch.*

### 3. Secondary Power Input\*

DC input for use where Power-over-Ethernet (PoE) is not available. Can be used in conjunction with PoE.

When both power supplies are available, PoE will be the default supply.

### 4. Line Out XLRs

Two balanced output channels which can, for example, be used for monitor loudspeakers. (Passive speakers will require external amplification.)

 \*For health and safety reasons, do not power-up RedNet AM2 while monitoring through headphones.

Refer to the Appendix on page 12 for connector pinouts.

## Physical Characteristics

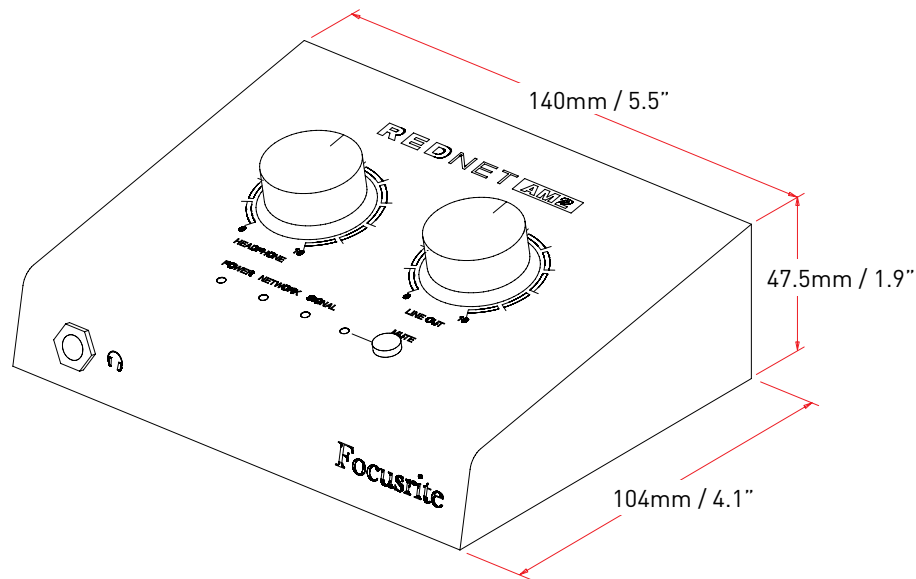

RedNet AM2 dimensions are illustrated in the diagram above.

RedNet AM2 weighs 0.81 kg and is equipped with rubber feet for desktop mounting. The baseplate includes a female 3/8" BSW thread so the unit can be mounted on a microphone stand.

RedNet AM2 generates little significant heat and is cooled by natural convection. The ambient operating temperature of the device is 50 degrees Celcius.

## Power Requirements

RedNet AM2 can be powered from two separate sources: Power-over-Ethernet (PoE) or DC input via external mains supply.

Standard PoE requirements are: 37.0–57.0 V @ 1–2 A (approx.) – as supplied by many suitably equipped switches and external PoE injectors. Note that PoE can only be accepted at Network Port 1 and that power is not transmitted as an output on Network Port 2.

*PoE injectors used should be Gigabit capable.*

To use the 12 V DC input, connect the external plugtop PSU supplied to an adjacent mains outlet.

*Only use the DC PSU supplied with RedNet AM2. Use of other external supplies may affect performance or could damage the unit.*

When both PoE and external DC supplies are connected, PoE becomes the default supply.

The power consumption of the RedNet AM2 is: PoE 11.0W and DC Supply 9.8W

Please note that there are no fuses in RedNet AM2, or other user-replaceable components of any type. Please refer all servicing issues to the Customer Support Team (see "Customer Support and Unit Servicing" on page 15).



# REDNET AM2 OPERATION

## First Use and Firmware Updates

Your RedNet AM2 may require a firmware update\* when it is first installed and switched on. Firmware updates are initiated and handled automatically by the RedNet Control application.

*\*It is important that the firmware update procedure is not interrupted – either by switching off power to the RedNet AM2 or the computer on which RedNet Control is running, or by disconnecting either from the network.*

From time to time Focusrite will release RedNet firmware updates within new versions of RedNet Control. We recommend keeping all RedNet units up to date with the latest firmware version supplied with each new version of RedNet Control.

*The RedNet Control application will automatically inform the user if there is a firmware update available.*

## Digital Clocking

Each RedNet AM2 will automatically lock to a valid Network Master via its Dante connection. Alternatively, if a Network Master is not already present, the unit can be chosen as the Network Master by the user.

## Pull Up and Pull Down Operation

RedNet AM2 is able to operate at a specified pull up or pull down percentage as selected in the Dante Controller application.

## OTHER REDNET SYSTEM COMPONENTS







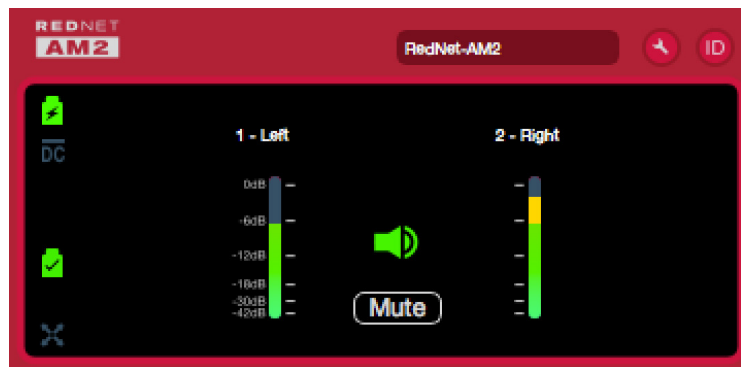

The RedNet hardware range includes various types of I/O interface and PCIe/ PCIeR digital audio interface cards which are installed in the system's host computer or in a chassis. All the I/O units can be considered as "Break-Out" (and/or "Break-In") boxes to/from the network, and all are built in mains-powered, 19" rackmount housings, unless otherwise stated. There are also three software items, RedNet Control (see below), Dante Controller and Dante Virtual Soundcard.

## USING REDNET CONTROL

RedNet Control will reflect the status of the RedNet units present in the system, presenting an image representing each hardware unit.



The illustration above shows a RedNet AM2 with the Line Out Mute inactive and shows signal present on both channels. It has PoE power available and has a locked network connection.

-   PoE power input – Illuminates if DC power is being received via the Ethernet cable.
-   DC supply power input – Illuminates if power is being received from the external DC supply.
-   Locked – Unit is successfully locked to the network (changes to the red cross if not locked).
-   Network Master – Illuminated indicating that this unit is the network master.

### Reverse ID

A Reverse ID request from a RedNet AM2 unit will flash the black background in the device GUI.

### Signal Metering

Both audio channels have a virtual signal level meter.

## ID (Identification)

Clicking on the ID icon  will identify the physical device being controlled by cycling its front panel “Network” and “Signal” LEDs through green–orange–red states for 10 seconds.

## Tools Menu

Clicking on the Tools icon  will gain access to the following system settings:

**Line Level Setup** – Sets the analogue line output level at 0 dBFS:

- +18 dBu
- +24 dBu (*factory default setting*)

**Mute (Line Out)** – On/Off state.

**Mute on Power-up** – On/Off state (*factory default is On*).

**Attenuation (Headphone)** – The headphone output volume can be attenuated for safety. Available settings are:

- 0 dB
- 6 dB
- 12 dB (*factory default setting*)

**Preferred Master** – On/Off state.

# APPENDIX

## Connector Pinouts

### Ethernet Connectors (Dante)

Connector type: RJ-45 (EtherCON) receptacle  
 Applies to: NETWORK 1 & 2

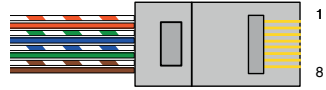

Pin	Cat 6 Core	PoE A	PoE B
1	White + Orange	DC+	
2	Orange	DC+	
3	White + Green	DC-	
4	Blue		DC+
5	White + Blue		DC+
6	Green	DC-	
7	White + Brown		DC-
8	Brown		DC-

*PoE information only applicable to Network port 1*

### XLR Connectors

Connector type: XLR(M)-3 receptacle  
 Applies to: LINE OUTPUT 1 & 2

Pin	Signal
1	Screen
2	Hot (+ve)
3	Cold (-ve)

### 1/4" Jack Connector

Connector type: Stereo receptacle  
 Applies to: Headphone output

Pin	Signal
Tip	Left
Ring	Right
Sleeve	Ground

# PERFORMANCE AND SPECIFICATIONS

Line Level Outputs	
<i>All measurements taken at +24dBu reference level, maximum gain, <math>R_L = 100k\Omega</math></i>	
0 dBFS Reference Level	+18 or +24 dBu (switchable)
Frequency Response	20Hz – 20kHz $\pm 0.5$ dB
THD + N	<-100dB (0.001%) unweighted, 20Hz - 20kHz; -1dBFS input
Dynamic Range	120dB 'A'-weighted (typical), 20Hz - 20kHz
Crosstalk (Output to Output)	<-100dB unweighted, 20Hz - 20kHz; -20dBFS input

Headphone Output	
<i>All measurements taken at +19dBm reference level, maximum gain, <math>R_L = 600\Omega</math></i>	
0 dBFS Reference Level	+19dBm
Frequency Response	20Hz – 20kHz $\pm 0.5$ dB
THD + N	<-100dB (0.001%) unweighted, 20Hz - 20kHz; -1dBFS input
Dynamic Range	118dB 'A'-weighted (typical), 20Hz - 20kHz
Output Impedance	5 $\Omega$
Headphone Impedance	32 $\Omega$ – 600 $\Omega$
Crosstalk (Output to Output)	<-90dB unweighted, 20Hz - 20kHz; -20dBFS input

Digital Performance	
Supported sample rates	44.1 / 48 / 88.2 / 96 kHz [-4% / -0.1% / +0.1% / +4.167%] at 24 bit
Clock Sources	Internal or from Dante Network Master

Connectivity	
<b>Front Panel</b>	
Headphone	1/4" stereo Jack socket
<b>Rear Panel</b>	
Line Output	2 x XLR-3 male
PSU (PoE and DC)	1 x PoE (Network Port 1) Input and 1 x DC 12V Barrel Input Connector.
Network	2 x etherCON NE8FBH, also compatible with standard RJ45 connectors (Accommodates rugged etherCON NE8MC*. Does not intermate with Cat 6 cable connector NE8MC6-MO and NKE65* cable)

<b>Front Panel Indicators / Controls</b>	
Power	LED illuminates Green when PoE is connected and Red when DC power is connected (PoE is the default power supply).
Network	Green LED: Indicates device is network master or network slave, shows valid network lock. Green/Red (flashing): Indicates device is locking to network. Red (flashing): Indicates device is attempting to identify a network.
Signal	Signal indicator LED for both network input channels. Green LED (> -42dBFS), Orange LED (> -6dBFS) and Red LED (0dBFS).
Mute	Red LED. Indicates that the XLR Line Outputs are currently muted.
Control Functions	2 x Pots (Independent control of Headphone Output Level and Line Out Level). 1 x Mute Switch (Mutes Line Out).

<b>Dimensions</b>	
Height ( <i>Chassis Only</i> )	48mm / 1.89"
Height ( <i>Inc. Pots and Feet</i> )	58mm / 2.28"
Width	140mm / 5.51"
Depth ( <i>Chassis Only</i> )	106.5mm / 4.19"
Depth ( <i>Inc. Connectors</i> )	116mm / 4.57"

<b>Weight</b>	
Weight	0.81 kg

<b>Power</b>	
Power over Ethernet (PoE)	Complies with IEEE 802.3af class 0 Power-over-Ethernet standard (PoE A or PoE B compatible)
DC Power Supply	1 x 12V 1.2A DC power supply
Power Consumption	PoE: 11.0W - DC:9.8W (When using supplied DC PSU)

## **Focusrite RedNet Warranty and Service**

All Focusrite products are built to the highest standards and should provide reliable performance for many years, subject to reasonable care, use, transportation and storage.

Very many of the products returned under warranty are found not to exhibit any fault at all. To avoid unnecessary inconvenience to you in terms of returning the product please contact Focusrite support.

In the event of a Manufacturing Defect becoming evident in a product within 12 months from the date of the original purchase Focusrite will ensure that the product is repaired or replaced free of charge.

A Manufacturing Defect is defined as a defect in the performance of the product as described and published by Focusrite. A Manufacturing Defect does not include damage caused by post-purchase transportation, storage or careless handling, nor damage caused by misuse.

Whilst this warranty is provided by Focusrite the warranty obligations are fulfilled by the distributor responsible for the country in which you purchased the product.

In the event that you need to contact the distributor regarding a warranty issue, or an out-of-warranty chargeable repair, please visit: [www.focusrite.com/distributors](http://www.focusrite.com/distributors)

The distributor will then advise you of the appropriate procedure for resolving the warranty issue. In every case it will be necessary to provide a copy of the original invoice or store receipt to the distributor. In the event that you are unable to provide proof of purchase directly then you should contact the reseller from whom you purchased the product and attempt to obtain proof of purchase from them.

Please do note that if you purchase a Focusrite product outside your country of residence or business you will not be entitled to ask your local Focusrite distributor to honour this limited warranty, although you may request an out-of-warranty chargeable repair.

This limited warranty is offered solely to products purchased from an Authorised Focusrite Reseller (defined as a reseller which has purchased the product directly from Focusrite Audio Engineering Limited in the UK, or one of its Authorised Distributors outside the UK). This Warranty is in addition to your statutory rights in the country of purchase.

## **Registering Your Product**

For access to Dante Virtual Soundcard, please register your product at: [www.focusrite.com/register](http://www.focusrite.com/register)

## **Customer Support and Unit Servicing**

You can contact our dedicated RedNet Customer Support team free of charge:

Email: [rednetsupport@focusrite.com](mailto:rednetsupport@focusrite.com)

Phone (UK): +44 (0)1494 462246

Phone (USA): +1 (310) 322-5500

## **Troubleshooting**

If you are experiencing problems with your RedNet AM2, we recommend that in the first instance, you visit our Support Answerbase at: [www.focusrite.com/answerbase](http://www.focusrite.com/answerbase)